

DETAIL FINISH
SCALE 2.000

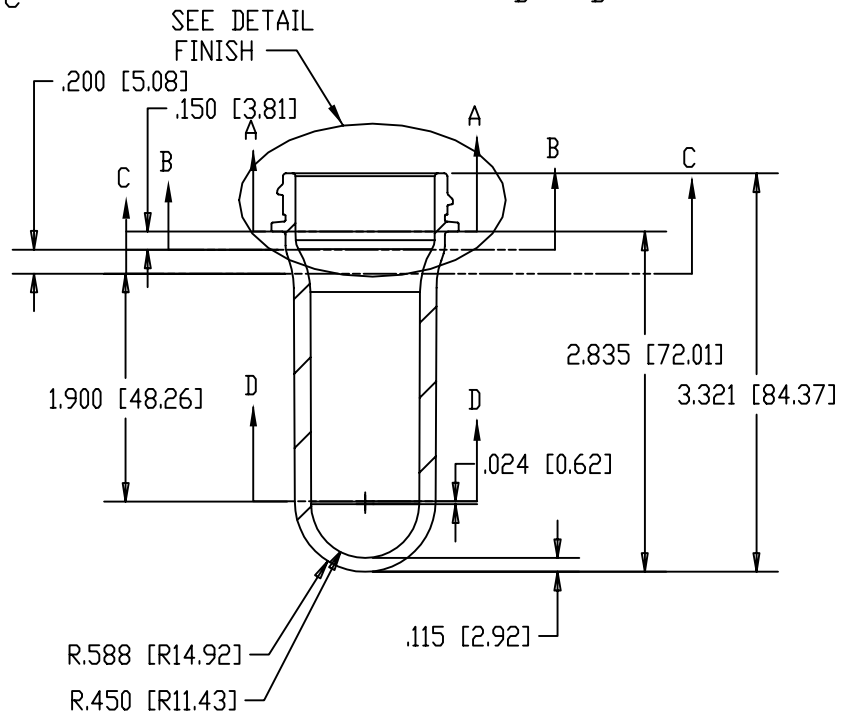
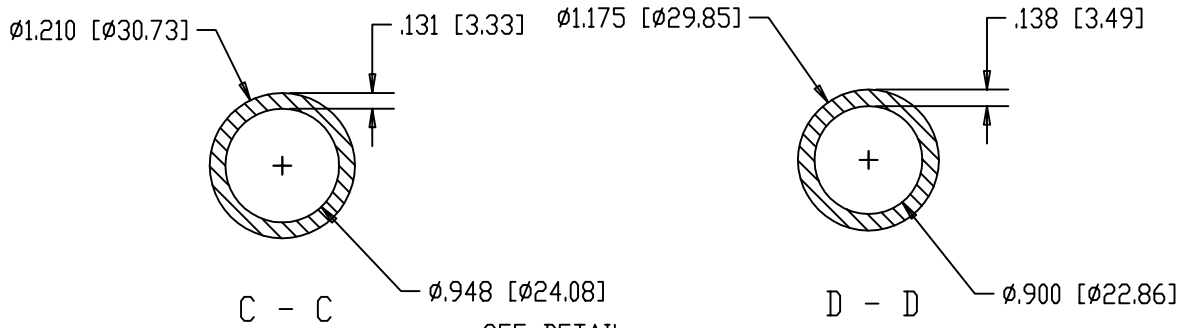
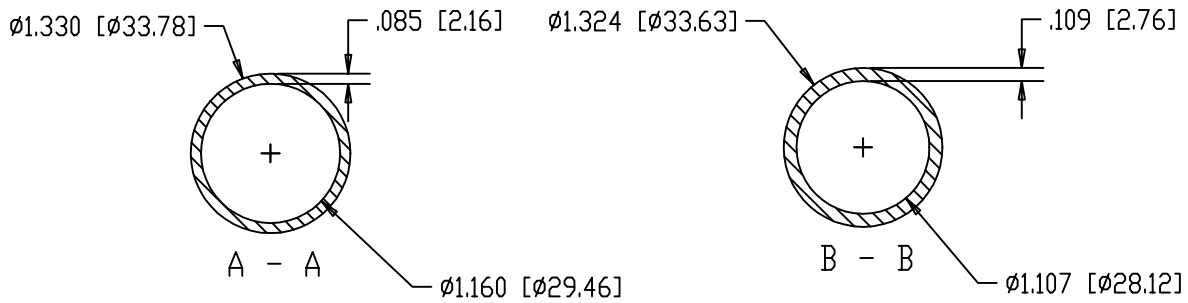

PROJ-225	38-MM SP400	
	DEVTECH LABS, INC.	
25-OCT-05 32.0-GRAMS ± 0.3	32.0-GRAM 38-MM SP400 PREFORM DESIGN	
	0031_06_PD_B_00	